

# Drinkwell®

## OUTDOOR DOG FOUNTAIN

450 oz  
(3.5 gal)



The Drinkwell® Outdoor Dog Fountain is intended for year-round indoor household use or seasonal outdoor use. Do not operate the fountain in temperatures below 40° F / 4.4° C.

**Read entire operating guide before using this product.**



protect. teach. love.

400-1413

[www.petsafe.net](http://www.petsafe.net)

1



protect. teach. love.

## WARRANTY

To get the most protection out of your warranty, please register your product within 30 days at [www.petsafe.net](http://www.petsafe.net).

By registering, and keeping your receipt, you will enjoy the product's full warranty and should you ever need to call the Customer Care Center we will be able to help you faster. Most importantly, PetSafe® will never give or sell your valuable information to anyone. Complete warranty information is available online at [www.petsafe.net](http://www.petsafe.net).

For a full listing of our Customer Care Center telephone numbers, visit our website at [www.petsafe.net](http://www.petsafe.net).

## Table of Contents

Warranty .....	2
Important Safety Instructions .....	3
Components .....	4
Features .....	4
Operating Instructions .....	5
Fountain Disassembly & Cleaning .....	7
Pump Maintenance .....	9
Fountain Reassembly .....	11
Understanding the Drinkwell® Fountain Parts .....	13
The Fountain and Your Environment .....	14
Tips on Use .....	15
Manufacturer's Safety Instructions .....	16



protect. teach. love.

## IMPORTANT SAFETY INSTRUCTIONS

**WARNING: When using electrical appliances, basic safety precautions should always be followed to reduce the risk of fire, electrical shock and/or injury to persons, including the following:**

1. Read all the instructions before using the appliance.
2. To reduce the risk of injury, close supervision is necessary when an appliance is used around children.
3. To protect against electrical shock, do not place cord or plug in water or other liquids.
4. Only use attachments recommended or sold by the manufacturer.
5. While the fountain is plugged in, do not attempt to touch any parts that may be moving.
6. Do not operate any appliance with a damaged cord or adaptor, or after the appliance malfunctions or has been dropped or damaged in any manner. Call customer service immediately for further instructions.
7. Always unplug any appliance when not in use for prolonged period of time, before putting on or taking off parts, and before cleaning. Never pull on the cord to remove the adaptor from the wall outlet.
8. Do not unplug by pulling on the electrical cord. To unplug, grasp the adaptor, not the cord.
9. Do not use the appliance for other than intended use.

**SAVE THESE INSTRUCTIONS**



U.S. Patents Numbers: 5799609, 5842437, 6055934

## OUTDOOR DOG FOUNTAIN

### Components

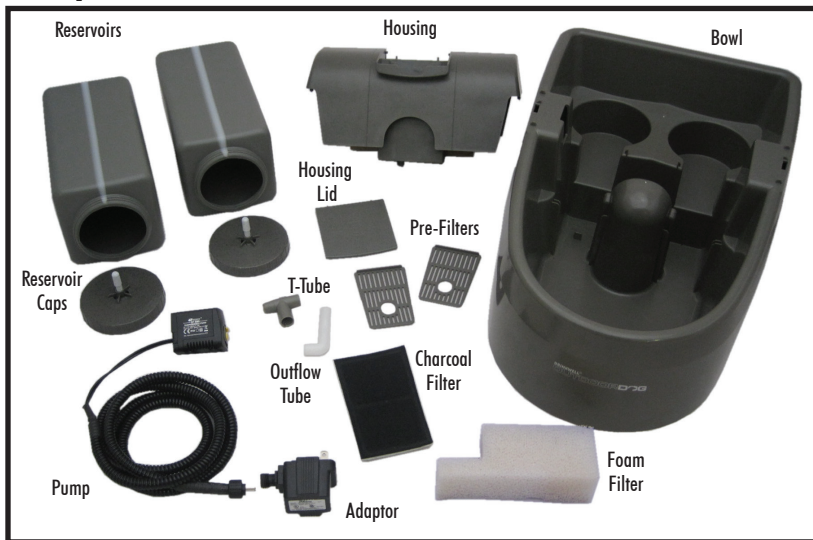

### Features

Fill-line indicator shows when to refill reservoirs

Replaceable Charcoal Filter removes bad tastes & odors

Low-Voltage (12V) Submersible Pump for quiet operation with Anti-Bite Cord Cover

Receiving ramp reduces splash of falling water

Dual water flow improves aeration & helps remove debris

Two 1-gallon reservoirs increase capacity & make refilling easy

Foam filter (inside housing) catches hair & debris before it reaches the pump

Patented free-falling stream of water entices pets to drink more

Pre-Filter catches hair & debris left in the bowl

**450 oz / 3.5 gallon Water Capacity**

UV Resistant Plastic & Dishwasher Safe (excluding pump)

# OPERATING INSTRUCTIONS

## DO NOT RUN DRY INDOOR HOUSEHOLD USE OR SEASONAL OUTDOOR USE

Fountain will come fully assembled and ready for use. Rinse fountain and reservoirs before using.

- 1) As with any electrical device, check the electrical cord for any tears, or damage before use.
- 2) Make sure the low-voltage power adaptor is tightly connected to the pump's electrical cord and that the threaded locking collar is tightened completely, see Figures 1a & 1b.

Fig. 1a

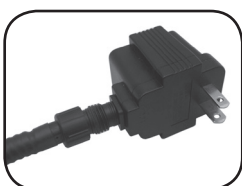
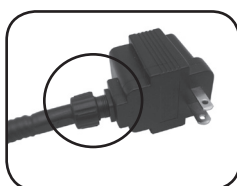

Fig. 1b



- 3) Your fountain comes equipped with two different filters, a charcoal filter that removes bad tastes and odors and a foam filter to trap larger debris before it reaches the pump.

### Installing the Charcoal Filter:

Open the housing lid to place the charcoal filter (one filter is included with your fountain). The Charcoal Filter fits between the grooves in the housing with the black side facing out towards the bowl, as shown in Figure 2. Make sure the filter is pushed all the way down and close the lid.

Fig. 2

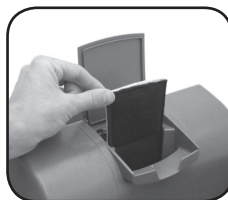

**IMPORTANT:** Rinse charcoal filter thoroughly under cool water before placing in the housing. This will remove any loose charcoal dust, which is harmless. A small amount of charcoal dust may shed for the life of the filter. This is normal and not harmful to your pet.

### Installing the Foam Filter:

The foam filter will come installed around the pump beneath the housing, as shown in Figure 3. You will be able to see the foam filter in place by looking through the pre-filter on the right side.

Fig. 3

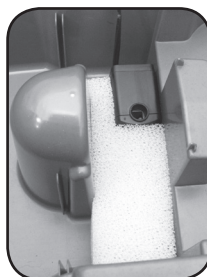

## OPERATING INSTRUCTIONS

- 4) Place the fountain in a desired location. The Outdoor Dog Fountain is intended for year-round indoor household use or seasonal outdoor use. Never operate the fountain in temperatures below 40° F / 4.4° C. Be sure the electrical cord comes out through the cord notch at the back of the fountain, so that it sits level on the floor (See Figure 4).

Fig. 4

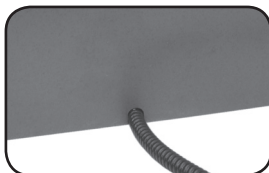

When placing the fountain Indoors, be sure to protect your floors from spills and splashes that can be caused by your pet. If placing on carpet, tile or wood - always use a protective mat.

When placing the fountain Outdoors, be sure the fountain is placed on a level surface. It is best to put the fountain in a covered location and out of direct sunlight if possible. By keeping the fountain in a shady spot, the water will stay cooler for your pet. It is essential that you monitor the water level and cleanliness of the fountain to prevent damage to the unit and maintain the best possible water conditions for your pets.

- 5) Fill the bowl with water just over the triangle shaped shelf on either side of the bowl. This is the height that the reservoirs will maintain the water level at, which provides a 'splash guard' to help keep water inside the bowl. Open the lid and fill the housing with water, this will prime the pump. Close the lid.
- 6) Fill both reservoirs and place behind the housing into the circular openings. The reservoir is designed to fit in any direction. Place the reservoir so that the fill-line indicator is in plain view. This will help you monitor the water level in your fountain and let you know when to refill the reservoirs.

### IMPORTANT:

Fountain is very heavy when full of water, never attempt to lift the fountain while it is full.

- 7) Before you plug the fountain into an electrical outlet, make sure your hands, the adaptor and the cord are dry. Plug the fountain in.

**IMPORTANT:** If using an extension cord, be sure it is not damaged nor has any exposed wires and that it is a properly rated power cord, for either indoor or outdoor use depending on the placement of the fountain. If your pet is prone to chewing, be sure to protect the extension cord from your pet with a power cord protector, available in many forms at most hardware stores.

# FOUNTAIN DISASSEMBLY & CLEANING

## FILTER SYSTEM

The fountain is equipped with two types of filters, both of which should be replaced on a regular basis. Replace filters more frequently when using the fountain for multiple pets or pets that produce a lot of saliva. A 3-layer charcoal filter removes bad tastes and odors, keeping water fresh. A foam filter collects hair and debris and prevents it from reaching the pump, providing optimal filtration. The filters together will keep the pump cleaner and provide fresher water for your pet.

### 3-Layer Charcoal Filter:

Change the charcoal filter **every 2 to 4 weeks** when used indoors and **every 1 to 2 weeks** when used outdoors. Charcoal filter may be rinsed out with water when fountain is cleaned and in between cleanings. Never wash the filter with soapy water, this will leave soap residue inside the filter and it will need to be discarded.

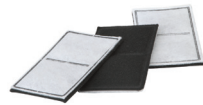

### Foam Filter:

Replace the foam filter **every 4 to 8 weeks**, depending on the location of the fountain and the number of pets using it. If you do not intend to replace the filter at the time of cleaning, rinse the foam filter thoroughly with fresh water.



Filters are an added feature of the fountain. Their use is not required for normal operation. However, when used properly and changed regularly, the filters help keep the water cleaner and fresher, while extending the life of your fountain.

---

---

## FOUNTAIN - CLEAN ONCE A WEEK

- 1) Unplug the fountain and remove the two reservoirs from the back. Unscrew the reservoir caps and pour out any remaining water and set aside. Reservoirs should not be placed in the dishwasher, hand wash only.
- 2) Open the housing lid and remove the charcoal filter. Grasp both cutouts on the side of the fountain bowl and pour out the remaining water.
- 3) Remove the two plastic pre-filters inside the bowl by pulling up on the top lip of the pre-filter, see Figure 5.

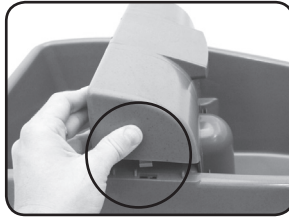

Fig. 5

## FOUNTAIN DISASSEMBLY & CLEANING

- 4) Remove the housing by gently pressing on each side of the housing where it locks into the bowl. Lift the housing straight up and set aside for cleaning, see Figure 6.

Fig. 6



- 5) Remove the T-Tube and Outflow Tube from the bottom of the housing and disassemble into two separate pieces, see Figures 7a and 7b.

Fig. 7a



Fig. 7b

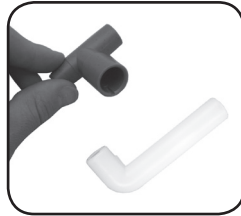

- 6) Next, remove the foam filter and rinse thoroughly in fresh water if you plan on reusing the filter after cleaning. Or discard in the garbage, if you plan on replacing with a new foam filter.
- 7) To remove the pump, take the power adaptor and unthread (untwist) the plastic locking collar by twisting to the left. Once completely removed from the threads, pull the electrical cord away from the adaptor and this will expose the two metal prongs. With the adaptor detached from the electrical cord, pull the cord through the opening on the inside of the bowl. Lift the pump and cord up from the bowl and set aside for further cleaning, see Figures 8a and 8b.

Fig. 8a

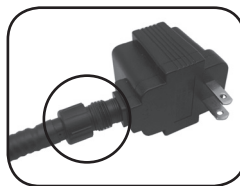
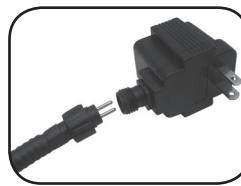

Fig. 8b





## FOUNTAIN DISASSEMBLY & CLEANING

- 8) The fountain should now be completely disassembled for proper cleaning. Wash the fountain parts with soap and warm water and rinse thoroughly. If placing the fountain parts inside the dishwasher, we recommend the top rack and/or silverware holder. If possible, turn down the temperature of the water inside the dishwasher. The pump and reservoirs are not dishwasher safe, hand wash only.

### CLEANING TIP:

If you have trouble reaching certain spots inside the fountain, try using a cotton swab or purchase a Drinkwell® Cleaning Kit that contains three different sized bottle brushes to help clean hard-to-reach spots.



- 9) Once the fountain is completely disassembled, you will have 11 plastic parts, the pump, the power adaptor and two filters. The lid detaches from the fountain's housing to make 11 pieces.

## PUMP MAINTENANCE

Cleaning the pump is essential to the longevity of the fountain, as well as the cleanliness of the water. Clean the pump every 2 weeks.

**IMPORTANT:** Warranty may be voided if the motor is not cleaned.

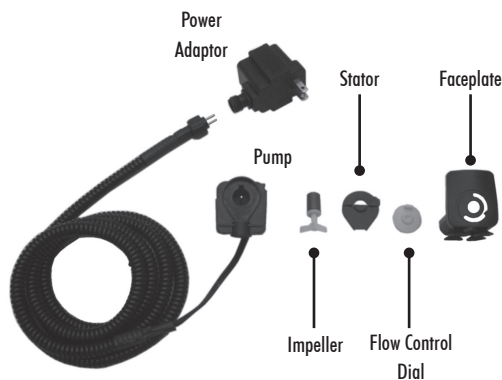

Model SP-880 [AC 12V~60Hz / 8.2 W]

# PUMP MAINTENANCE

- 1) Remove the faceplate from the pump by inserting a fingernail or other slim object, into the seam and pull straight out (see Figure 9).

Fig. 9



Fig. 10



- 2) Once the faceplate is removed, the yellow dial that controls the water flow intensity will become free. Place the faceplate and flow control dial to the side for cleaning.
- 3) Next, remove the stator by positioning your fingernail or other slim object underneath the tab and pull up, see Figure 10 above.
- 4) With the stator removed, reach inside the pump's cavity and grab one of the plastic blades on the impeller and lift straight up. The impeller is held in place magnetically and you will experience a slight resistance when removing this piece, see Figures 11a & 11b.

Fig. 11a



Fig. 11b



- 5) Once the pump is completely disassembled, you can clean all the parts with soap and warm water. Use a cotton swab or the Drinkwell® Cleaning Kit Motor Brush to get inside the pump's cavity and clean any build-up. For additional disinfecting and hard water spot removal, clean the motor with a white vinegar and water solution.
- 6) When the parts are clean, reassemble the pump for use:
  - a) Replace the Impeller
  - b) Replace the Stator
  - c) Replace the Flow Control Dial and Faceplate

## FOUNTAIN REASSEMBLY

- 1) Check the flow control dial make sure the dial is positioned at the desired flow rate. When the yellow tab is closest to the "+" sign, the pump is set at maximum flow. When the yellow tab is closest to the "-" sign, the pump is set at its lowest flow (see images below).



**MAX FLOW**



**MIN FLOW**

- 2) Replace the pump between the two posts on the bottom of the bowl with the suction cups face down. Feed the electrical cord through the opening on the inside of the bowl. Insert the two prongs into the adaptor and re-thread the plastic locking collar onto the adaptor, until no threads show. See Figures 12a & 12b.

Fig. 12a

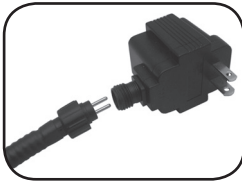
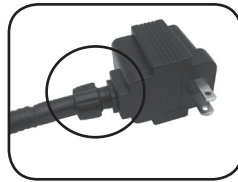
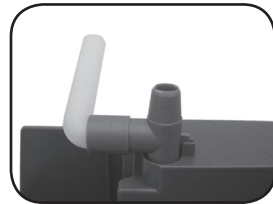

Fig. 12b



- 3) Feed the cord underneath the bowl and out the backside through the cord notch. Do not plug the fountain into electricity until the fountain is filled with water and your hands are dry.
- 4) With the pump in place and suctioned to the bowl, replace the foam filter in its original position. See Page 5 of this operating guide for exact placement.
- 5) Next, connect the T-Tube and the Outflow Tube together. With the pieces connected, affix the T-Tube to the bottom of the housing as shown in Figure 13. Make sure the T-Tube is pressed all the way down, so that the little notch clips into the holder on the bottom of the housing.

Fig. 13



## FOUNTAIN REASSEMBLY

- 6) If the housing lid was removed during cleaning, replace and then proceed to the next step.
- 7) Replace the housing by lining up the locking tabs with the openings on the top of the bowl; gently push down until you hear the tabs lock in place.
- 8) Next, replace the two pre-filters by simply sliding into place with the raised lip facing out.
- 9) Fill both of the reservoirs with water and replace the reservoir caps, make sure they are tightened all the way. Set reservoirs upside down with the caps facing up, until the fountain and housing is filled with water.
- 10) Rinse the charcoal filter under cold water to remove any loose charcoal dust. Insert the filter narrow side down with the black side facing out towards the bowl. The filter will slide easily into place, but make sure it is pushed all the way down.
- 11) Place the fountain in a desired location. The Outdoor Dog Fountain is intended for year-round indoor household use or seasonal outdoor use. Do not operate the fountain in temperatures below 40° F/4.4° C. Be sure the electrical cord comes out through the cord notch at the back of the fountain, so that it sits level on the floor.

**When placing the fountain Indoors**, be sure to protect your floors from spills and splashes that can be caused by your pet. If placing on carpet, tile or wood - always use a protective mat.

**When placing the fountain Outdoors**, be sure the fountain is placed on a level surface. It is best to put the fountain in a covered location and out of direct sunlight if possible. By keeping the fountain in a shady spot, the water will stay cooler for your pet.
- 12) Fill the fountain with water. This includes both the bowl and the housing. Replace the two reservoirs on the back of the fountain with the fill-line indicators in plain view. This will help you monitor the water level in your fountain and let you know when to refill the reservoirs.
- 13) Make sure the cord, the adaptor and your hands are completely dry, then plug the fountain into an electrical outlet.

# UNDERSTANDING THE DRINKWELL® OUTDOOR DOG PARTS

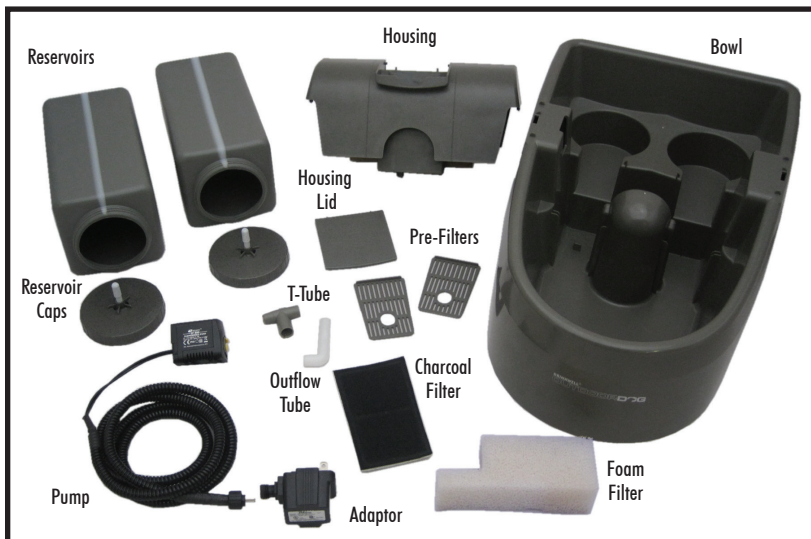

- 1) **Bowl:** the bowl is the foundation of the fountain and provides a large drinking area for pets. The bowl features cutouts on the sides to help carry and place the fountain.
- 2) **Housing/Filter Housing:** the water is pumped up through the housing to cycle through a charcoal filter and out the spout to create a free-falling stream of water for pets to drink from.
- 3) **Housing Lid:** snaps on to the back of the housing and encloses the filter.
- 4) **Pre-Filters:** this fountain features two plastic pre-filters that are small intake grates that will catch large particles, such as hair and food, before they reach the pump and foam filter. The pre-filters can easily be removed and rinsed off while the fountain is running.
- 5) **Charcoal Filter:** is a replaceable 3-layer charcoal filter with granulated carbon made from coconut shells. The charcoal filter absorbs bad tastes and odors as the water passes through the filter and helps keep the water tasting fresh and appealing to pets. The duo-density polyester pad helps catch hair and debris to keep the water cleaner.
- 6) **Foam Filter:** is intended to catch large debris, hair and food left in the water before it reaches the pump. Improves the overall cleanliness of the water and the pump in between cleanings.
- 7) **T-Tube:** connects with the Outflow Tube and directs water from the pump into the housing, to be filtered and pour out into a free-falling stream.

## UNDERSTANDING THE DRINKWELL® OUTDOOR DOG PARTS

- 8) **Outflow Tube:** connects with the T-Tube and directs water from the pump into the bowl, to create a current within the bowl to help move debris and dirt towards the filter.
- 9) **Pump:** a submersible pump that features an anti-bite cord cover and outdoor rated power adaptor. (Model SP-880 - AC 12V ~60Hz / 8.2 W) **THE PUMP IS NOT DISHWASHER SAFE, hand wash only as instructed in the "Pump Maintenance" section of this operating guide.** Always unplug and remove the pump prior to cleaning the fountain.
- 10) **Reservoirs:** the fountain features two 1-gallon reservoirs to increase the capacity, maintain the water level and keep the fountain filled longer. The reservoirs feature a fill-line indicator on the side to let you know when they need to be refilled. **Reservoirs are not Dishwasher Safe, Hand Wash Only.**
- 11) **Reservoir Cap:** affixes to the top of the reservoir and the plugging cap will release water from the reservoirs as needed to maintain the water level in the fountain's bowl.

## THE FOUNTAIN & YOUR ENVIRONMENT

If you live in a humid environment and have problems with mold or algae, soak all the parts in a diluted bleach solution for about 10 minutes after regular cleaning. Use a 10% bleach and 90% water solution. Pour some of the solution down into the pump's cavity too. This is a great way to disinfect the fountain. However, you must be sure to rinse all the parts thoroughly in fresh water to remove all the chlorine.

If you have hard water, you may start to see white mineral deposits on or inside the pump. This can eventually prevent the impeller from turning properly. To avoid having to replace the pump, please take the following steps:

1. Clean the pump more frequently than you have in the past; or
2. Clean the motor with a vinegar solution (20% White Vinegar and 80% Water) and let the solution soak inside the pump's cavity for several minutes; or
3. Use bottled water instead of faucet water.

## TIPS ON USE

- 1) When being introduced to the Drinkwell® Pet Fountain, your pet may be cautious of this new and unusual object. After beginning operation of your fountain, simply allow your pet to adjust at his or her own pace. Some pets may take several days or longer to begin use, while others will start right away.
- 2) Your pet may prefer that the fountain be placed away from their normal feeding area. Try placing it in another location, such as a different area of the kitchen or in a bathroom or utility room.
- 3) Add ice cubes to the bowl or reservoirs for refreshing, ice-cold running water!

**450 oz  
(3.5 gal)**



# MANUFACTURER'S SAFETY INSTRUCTIONS

- 1) It is not recommended that any appliance be left running unattended for a prolonged period of time as the water may get consumed or evaporate and cause the motor to run dry.
- 2) Do not allow pets or children to chew on or swallow any parts. If you are concerned about the power cord, purchase a cord conduit (a hard plastic protector) at any local hardware store.

### 3) Standard Safety Precautions

Do not attempt repairs on the motor yourself. Return it under the cover of the warranty.

If the plug of this device gets wet, turn off the electricity to that outlet. Do not attempt to unplug.

To avoid the possibility of the plug or outlet getting wet, the outlet should always be above the level of the fountain.

Examine this appliance after installation. It should not be plugged in if there is water on the cord or plug.

Do not operate any appliance if it has a damaged cord or plug, or if it is malfunctioning or has been damaged.

If an extension cord is necessary, a cord with a proper rating should be used.

The electrical use of this appliance is 8.2 watts.

Close supervision is necessary when any appliance is used by or near children.

Always unplug any appliance when not in use, before putting on or taking off parts, and before cleaning. Never pull on an electrical cord to remove from the outlet.

Do not use appliance for anything other than its intended use. The use of attachments not recommended or sold by the manufacturer may cause an unsafe condition. Do not modify the unit.

Do not install or store appliance where it will be exposed to weather or temperatures below 40° F / 4.4° C.

Read and observe all important notices on the appliance and in the packaging.

- 4) Some animals have been known to be sensitive to plastic food and water containers. If your animal shows signs of an allergic reaction to the plastic, please discontinue use until you have consulted with your veterinarian.



**The Outdoor Dog Fountain is intended for year-round indoor household use or seasonal outdoor use. Do not operate the fountain in temperatures below 40° F/4.4° C.**